

Staffa standard

Staffa ad "L" ricavata da estrusione di alluminio, con lunghezza 180 mm.
Base sagomata predisposta per l'applicazione di thermostop.

Standard brackets

"L" shape bracket produced by aluminium extrusion, 180 mm length.
Element ready to be combined with thermostop.

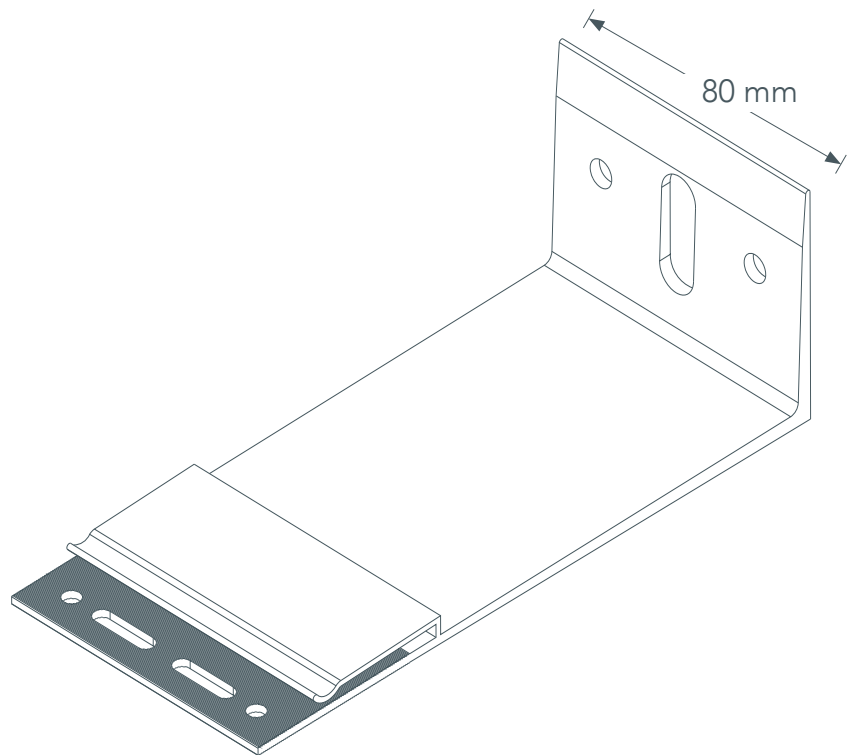
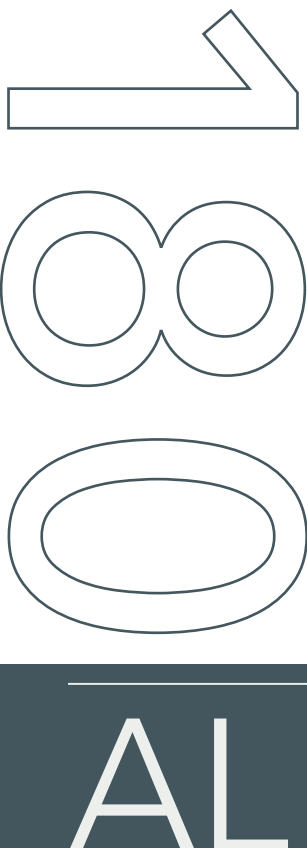
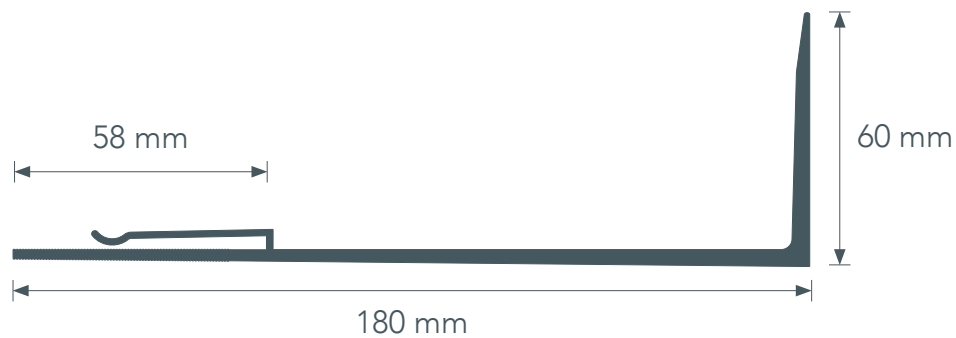

Titolo/title: Staffa AL180
Materiale/material: Alluminio
Lega/alloy: 6063 T66
Data/date: 01/06/23

Altezza/height: 60 mm
Base/base: 80 mm
Spessore/thickness: 4 mm

Range adattabilità/adjustment:
185 mm/
225 mm