

## Staffe standard

Staffa ad "L" ricavata da stampaggio di acciaio inox, con lunghezza 120 mm.  
Base sagomata predisposta per l'applicazione di thermostop.

## Standard brackets

"L" shape bracket produced by stainless steel molding, 120 mm length.  
Element ready to be combined with thermostop.

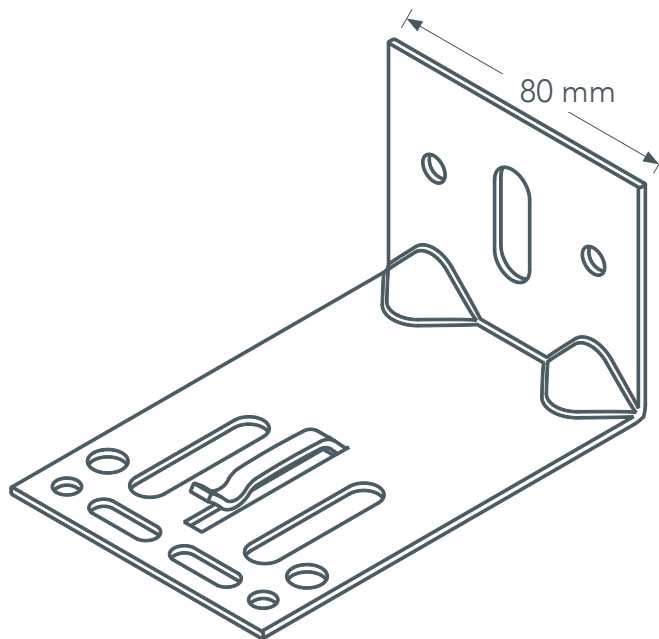
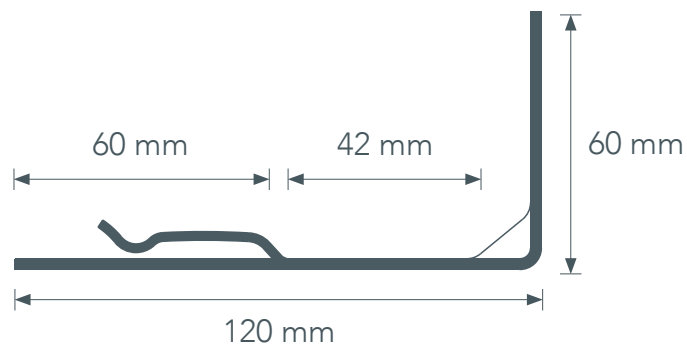
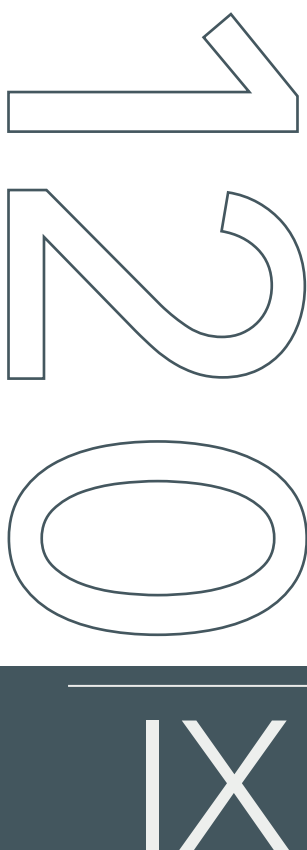

Titolo/title: Staffa IX 120

Materiale/material: Acciaio inox

Lega/alloy: AISI 304

Data/date: 01/06/23

Altezza/height: 60 mm

Base/base: 80mm

Spessore/thickness: 2,5 mm

Range adattabilità/  
adjustment:

128 mm/  
168 mm