

Staffe standard

Staffa ad "L" ricavata da stampaggio di acciaio inox, con lunghezza 180 mm.
Base sagomata predisposta per l'applicazione di thermostop.

Standard brackets

"L" shape bracket produced by stainless steel molding, 180 mm length.
Element ready to be combined with thermostop.

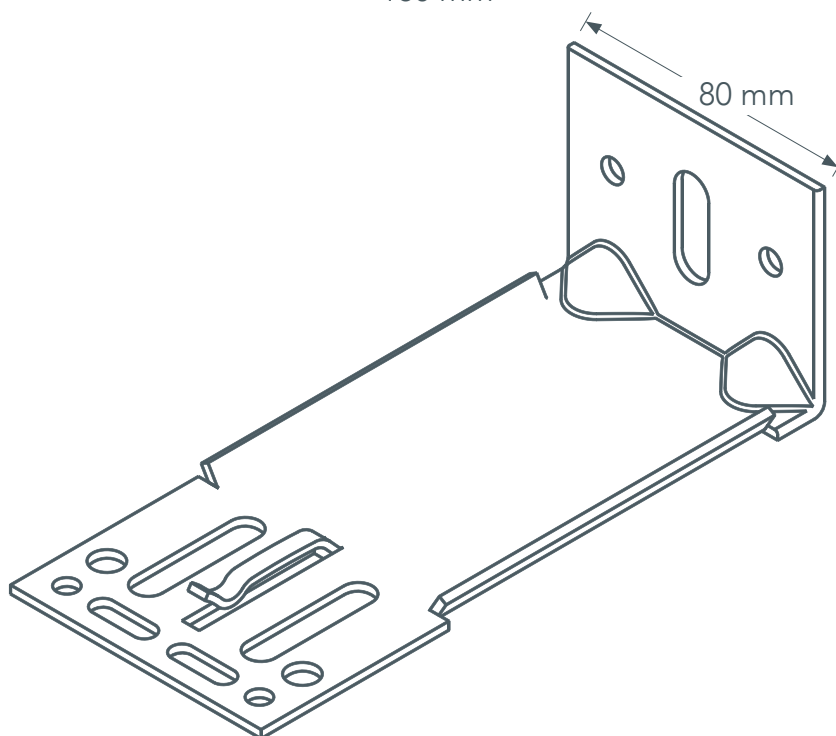
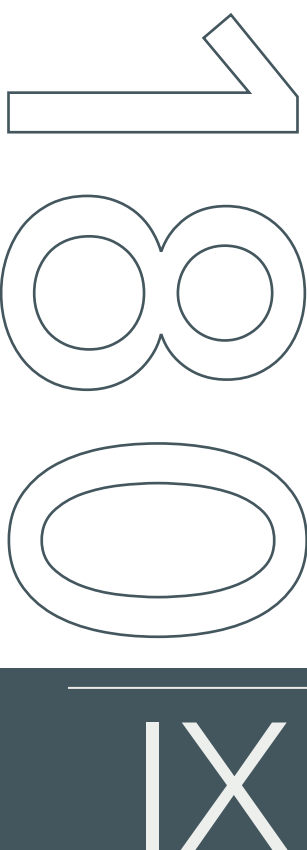
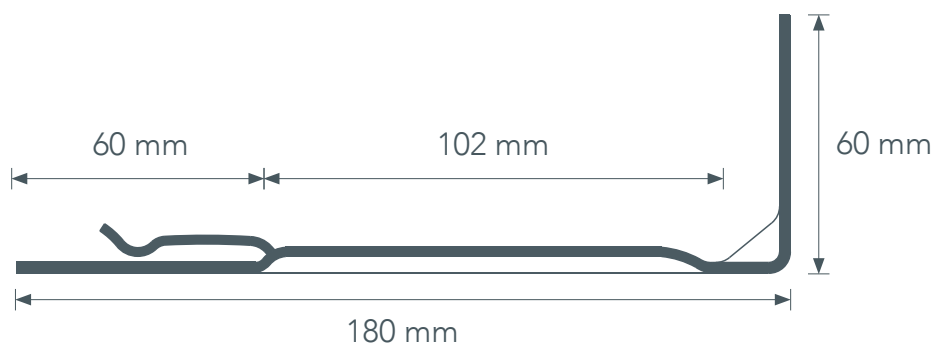

Titolo/title: Staffa IX 180

Materiale/material: Acciaio inox

Legg/alloy: AISI 304

Data/date: 01/06/23

Altezza/height: 60 mm

Base/base: 80 mm

Spessore/thickness: 2,5 mm

Range adattabilità/
adjustment:

185 mm/
225 mm