

Staffe standard

Staffa ad "L" ricavata da stampaggio di acciaio inox, con lunghezza 265 mm.
Base sagomata predisposta per l'applicazione di thermostop.

Standard brackets

"L" shape bracket produced by stainless steel molding, 265 mm length.
Element ready to be combined with thermostop.

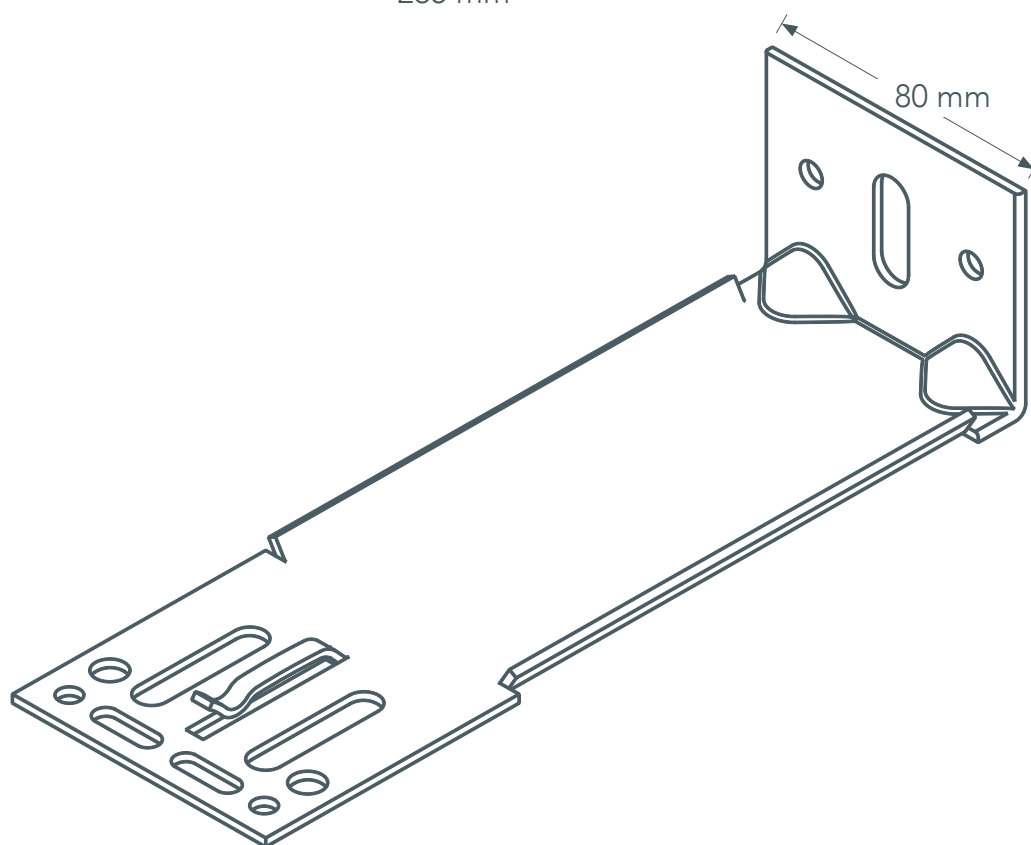
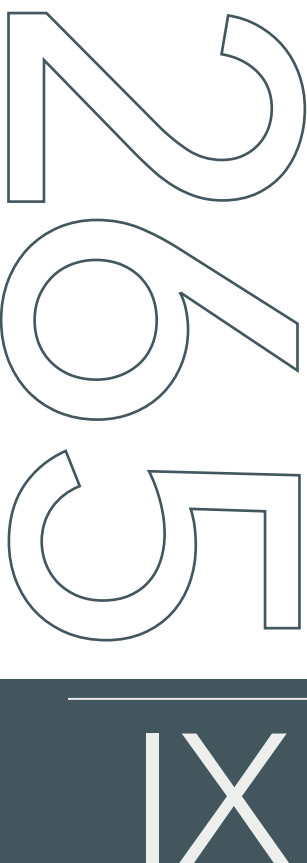
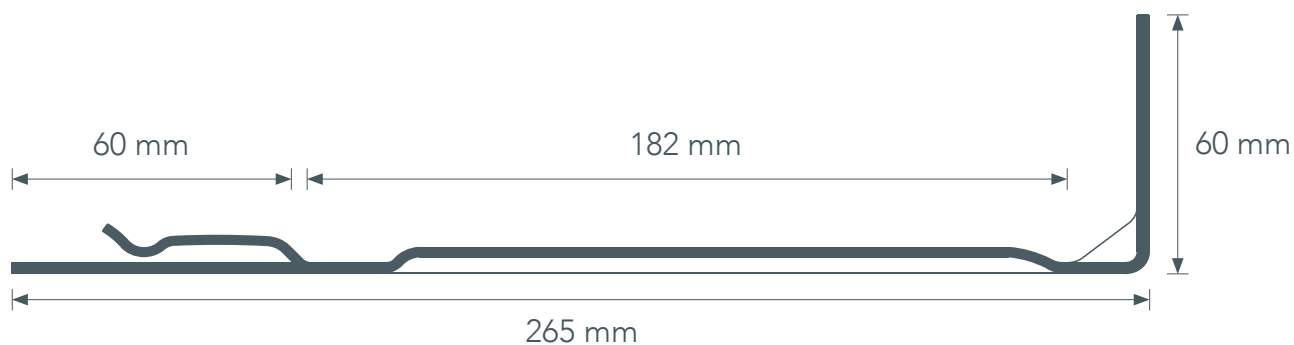

Titolo/title: Staffa IX 265

Materiale/material: Acciaio inox

Lega/alloy: AISI 304

Data/date: 01/06/23

Altezza/height: 60 mm

Base/base: 80 mm

Spessore/thickness: 2,5 mm

Range adattabilità/
adjustment:

270 mm/
310 mm