

Staffe standard

Staffa ad "L" ricavata da stampaggio di acciaio inox, con lunghezza 90 mm.
Base sagomata predisposta per l'applicazione di thermostop.

Standard brackets

"L" shape bracket produced by stainless steel molding, 90 mm length.
Element ready to be combined with thermostop.

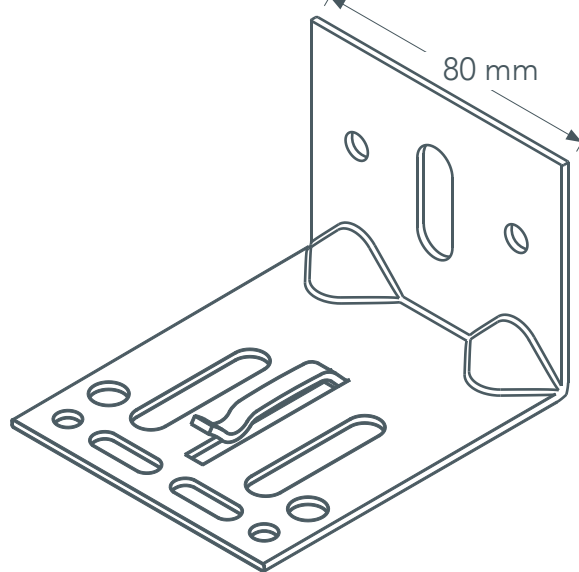
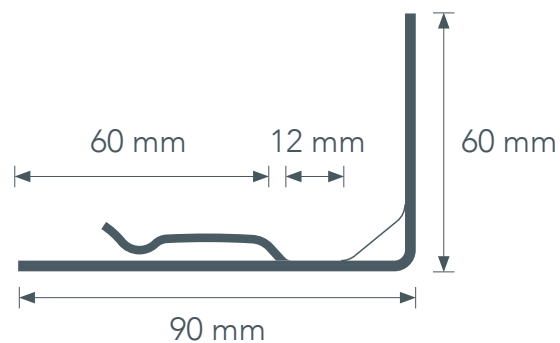
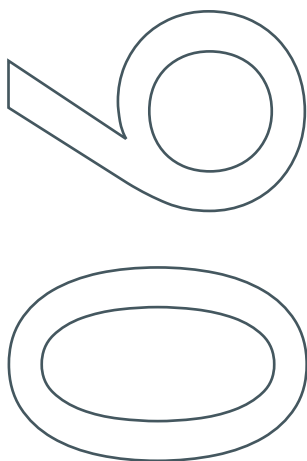

Titolo/title: Staffa IX 90

Materiale/material: Acciaio inox

Legg/alloy: AISI 304

Data/date: 01/06/23

Altezza/height: 60 mm

Base/base: 80mm

Spessore/thickness: 2,5 mm

Range adattabilità/
adjustment:

98 mm/
138 mm