

## Staffa premium 150 mm

Staffa ad "L" ricavata da stampaggio di acciaio inox, con lunghezza 150 mm. Base sagomata predisposta per l'applicazione di thermostop.

## Premium brackets 150 mm

"L" shape bracket produced by stainless steel molding, 150 mm length. Element ready to be combined with thermostop.

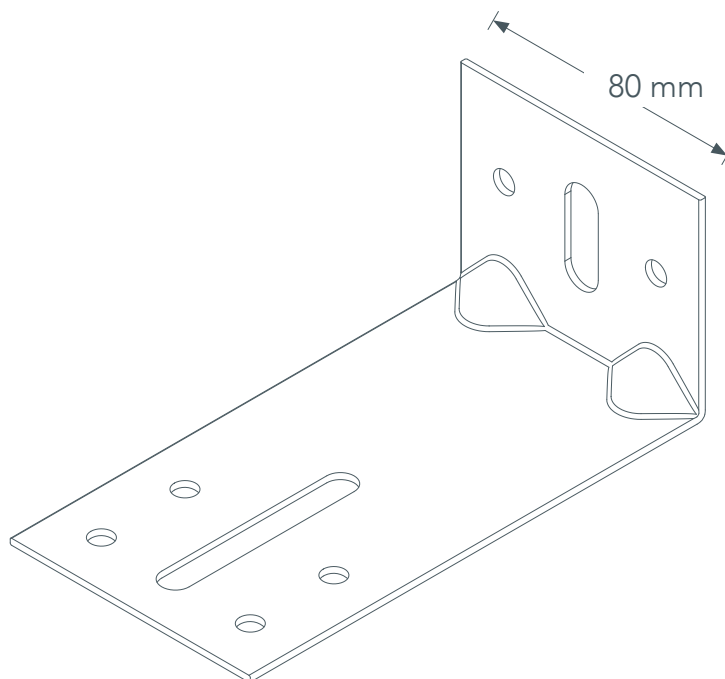
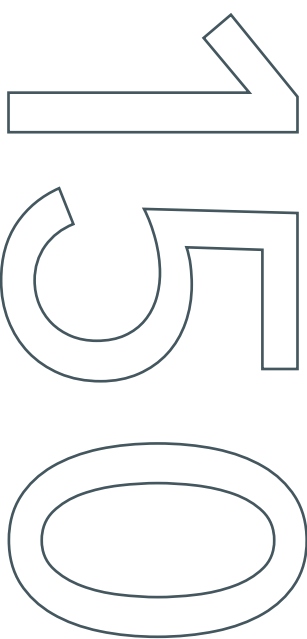
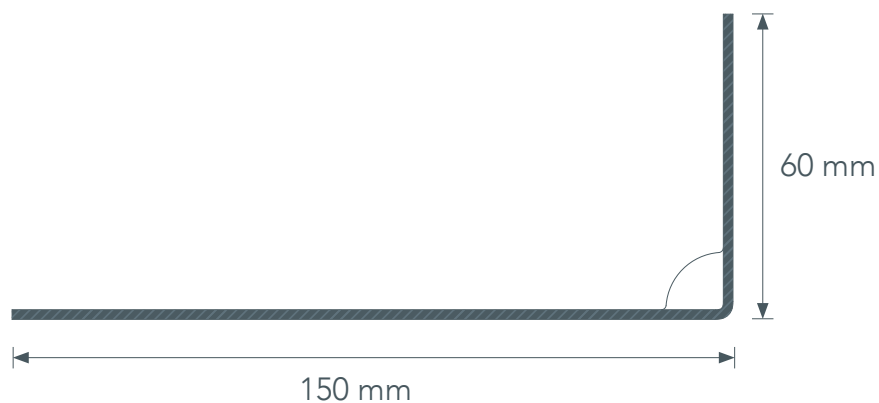

Titolo/title: Staffa IX 150

Materiale/material: Acciaio inox

Lega/alloy: AISI 304

Data/date: 13/08/20

Altezza/height: 60 mm

Base/base: 80mm

Spessore/thickness: 2,5 mm

Profili applicabili/available profiles: L1 e T1

Range adattabilità/  
adjustment:

152mm/  
192 mm

