

Staffa standard 90 mm

Staffa ad "L" ricavata da estrusione di alluminio, con lunghezza 90 mm.
Base sagomata predisposta per l'applicazione di thermostop.

Standard brackets 90 mm

"L" shape bracket produced by aluminium extrusion, 90 mm length.
Element ready to be combined with thermostop.

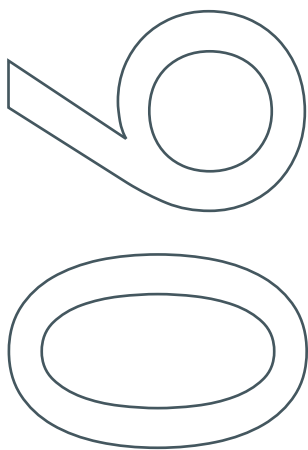
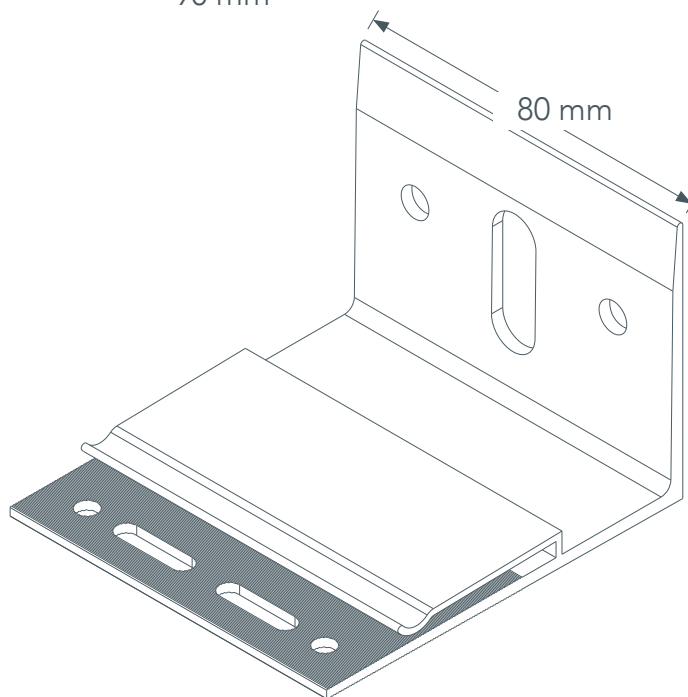
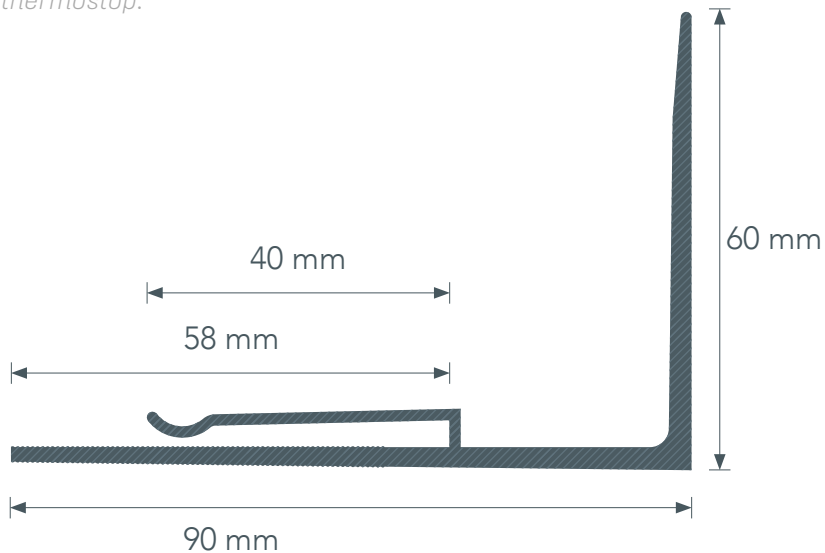

Titolo/title: Staffa AL90

Materiale/material: Alluminio

Lega/alloy: 6063 T66

Data/date: 13/08/20

Altezza/height: 60 mm

Base/base: 80mm

Spessore/thickness: 4 mm

Profili applicabili/available profiles: L1 e T1

Range adattabilità/
adjustment:

102 mm/
132 mm

